

BASKET TYPE STRAINER

TECHNICAL PASSPORT

FLANGED PN40 BASKET STRAINER CARBON STEEL BODY

F5266

APPLICATION

The basket filter is intended to be installed upstream of pumps, water meters, control valves and control devices to fight against the presence in the system of unwanted materials such as: . leaves, pieces of wood, pieces of stone, etc.



Fluids: clear water , compatible liquids.



GENERAL CHARACTERISTICS

Range: from DN1100 to DN1200.

- Hermetically closed cylindrical body
- Perforated sheet basket (holes: 5mm) easily removable
- ISO flanges for pipe mounting
- Unidirectional operation: mounting direction is indicated by an arrow on the body

Epoxy coating: Liquid epoxy coated body (RAL 5005, 250 microns)

STANDARDS

Connection	Flange connection PN40 according to EN1092-2, ISO 7005/2 , BS4504.
------------	--

PRODUCT APPROVALS

ERC

Tecofi France

83 rue Marcel Mérieux - 69960 Corbas
Tél. +33 (0)4 72 79 05 79 - Fax. +33 (0)4 78 90 19 19
E-mail : sales@tecofi.fr - www.tecofi.fr



BASKET TYPE STRAINER

TECHNICAL PASSPORT

F5266

CONSTRUCTION



Pos.	Description	Material
1	Body	Carbon steel
2	Cover	Carbon steel
3	Screen	Stainless steel 304
4	Gasket	NBR
5	Screw	Stainless steel A2
6	Nut	Stainless steel A2
7	Washer	Stainless steel A2
8	Plug	Brass
9	Eyebolt	Stainless steel 304
10	Drain plug	Stainless steel 304

DIMENSIONS

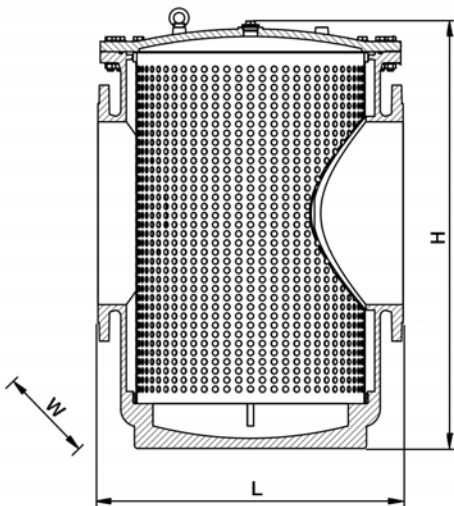

DN		L	H	W	Weight (kg)
mm	inch				
1100	48"	1650	2914	1560	2540
1200	52"	1800	2930	1750	2690

WORKING CONDITIONS

Maximum working pressure : 40 bar
 Maximum working temperature : -10°C / 80°C

Tecofi France

83 rue Marcel Mérieux - 69960 Corbas
 Tél. +33 (0)4 72 79 05 79 - Fax. +33 (0)4 78 90 19 19
 E-mail : sales@tecofi.fr - www.tecofi.fr

