

TERMINAL CHECK VALVE

TECHNICAL PASSPORT

STAINLESS STEEL TERMINAL CHECK VALVE

CBT6209A

APPLICATION

TECOFI terminal valve is used to protect pipes against the rise of fluid and the passage of animals.

Areas of use: waste water and industrial treatment, irrigation networks, rainwater tank



Fluids: clear water , waste water.



GENERAL CHARACTERISTICS

Range: from DN200 to DN2000.

- Welded construction with stainless steel body and plate
- Reduced face to face
- Easy and quick instauration
- Low head losses
- Easy opening thanks to the eccentric plate
- Metal/elastomer sealing
- Installation at the end of the networks on a vertical wall or a standard flange.

STANDARDS

Connection	Wall mounting in accordance with standard DIN 18202.
------------	--

PRODUCT APPROVALS

ENAC

Tecofi France

83 rue Marcel Mérieux - 69960 Corbas
Tél. +33 (0)4 72 79 05 79 - Fax. +33 (0)4 78 90 19 19
E-mail : sales@tecofi.fr - www.tecofi.fr



TERMINAL CHECK VALVE

TECHNICAL PASSPORT

CBT6209A

CONSTRUCTION

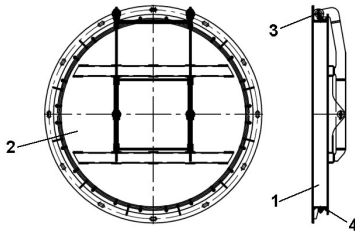

Pos.	Description	Material
1	Body	Stainless steel 316
2	Disc	Stainless steel 316
3	Axis	Stainless steel 316
4	Gasket	EPDM

DIMENSIONS

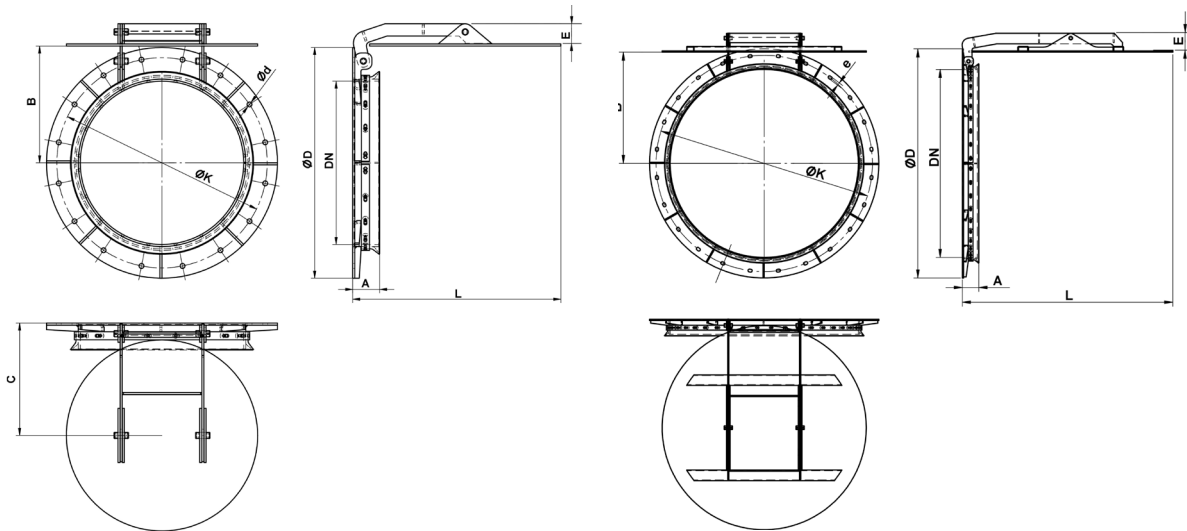

DN200-500

DN600-2000

DN		A	B	C	ØD	E	ØK	L	Ød	e	Weight (kg)
mm	inch										
200	8"	65.75	-	150	340	51.25	295	285	12	-	9
300	12"	66	227	230.84	445	51	400	400	12	-	13
400	16"	66	286	275	565	51	515	509	12	-	19
500	20"	66	334	310	670	51	620	607	12	-	24
600	24"	70.5	381	-	755	74.5	705	702	-	12	33
700	28"	70.5	-	-	860	74.5	810	800	-	12	41
800	32"	70.5	474	-	975	74.5	920	895	-	12	50
900	36"	70.5	523	-	1075	91.5	1020	995	-	12	65
1000	40"	73	559	-	1175	89	1120	1080	-	12	75
1200	48"	74.25	662	-	1375	87.75	1320	1283	-	12	96
1300	52"	153.5	739	-	1475	-	1420	1455	-	14	
1400	56"	153.5	797	-	1575	-	1520	1561	-	14	
1500	60"	153.5	849	-	1680	-	1625	1665	-	14	
1600	64"										
1700	68"										
1800	72"										
2000	80"	153.5	1112	-	2190	-	2130	2179	-	14	

WORKING CONDITIONS

Maximum working pressure : 5 mCE

Tecofi France

83 rue Marcel Mérieux - 69960 Corbas
 Tél. +33 (0)4 72 79 05 79 - Fax. +33 (0)4 78 90 19 19
 E-mail : sales@tecofi.fr - www.tecofi.fr

