

VANNE À PASSAGE DIRECT GATE VALVE

**VANNES À OPERCULE
CAOUTCHOUC**
RESILIENT SEAT GATE
VALVES **190 > 197**

KIT VOC ENTERRÉES
KIT FOR BURIED
RESILIENT SEAT GATE
VALVES **198 > 199**

KIT COLONNETTE
PEDESTAL KIT
200 > 203

CONSEILS TECHNIQUES
TECHNICAL NOTES
204 > 205

**VANNES À PASSAGE
DIRECT | GATE VALVES**
206 > 208

VANNES À MANCHON
PINCH VALVES
208 > 209

VANNE OPERCULE CAOUTCHOUC

RESILIENT SEAT GATE VALVE

EN 1074



ACS

TIGE INOX 420

420 Stainless steel stem

ANNEAUX DE LEVAGE

à partir du DN200 pour faciliter la manutention
Lifting hooks to facilitate handling from DN200

CIRE DE PROTECTION DE LA BOULONNERIE

Wax-protected bolts

PEINTURE EPOXY

cuite au four 250 microns intérieur et extérieur
250 microns interior and exterior epoxy coating

RACCORDEMENT DOUBLE PERÇAGE

PN10 et PN16 jusqu'au DN600
Double connection drilling PN10 & PN16 up to DN600

TALON D'APPUI

Heel support

TROU DANS L'AXE EXTÉRIEUR

Pour fixation rapide et directe sur les tiges de rallonge
Pin hole in spindle for quick and secure stem extension assembly

CACHE POUSSIÈRE

Dust cap

BOUCHON DE PURGE

En laiton à partir du DN300
Brass drain plug from DN300

À partir du DN300 sur vanne verticale, nous vous conseillons l'ajout du purgeur d'air automatique PU1100 (voir page 252).
From DN300 on vertical valve, we recommend adding the PU1100 automatic air trap (see page 252).



PROTECTION ELASTOMÈRE DU CORPS CONTRE LES CHOC

Elastomer protection against shock to valve body

OPERCULE EN FONTE DUCTILE

Entièrement revêtue EPDM
EPDM-lined ductile iron wedge



Résistance à la corrosion

✓ Les vannes sont revêtues de peinture époxy 250µm à l'extérieur et à l'intérieur du corps et du chapeau pour assurer une protection contre la corrosion.

Corrosion Resistance

✓ The valves are 250µm epoxy paint coated on the outside and inside of the body and the bonnet.

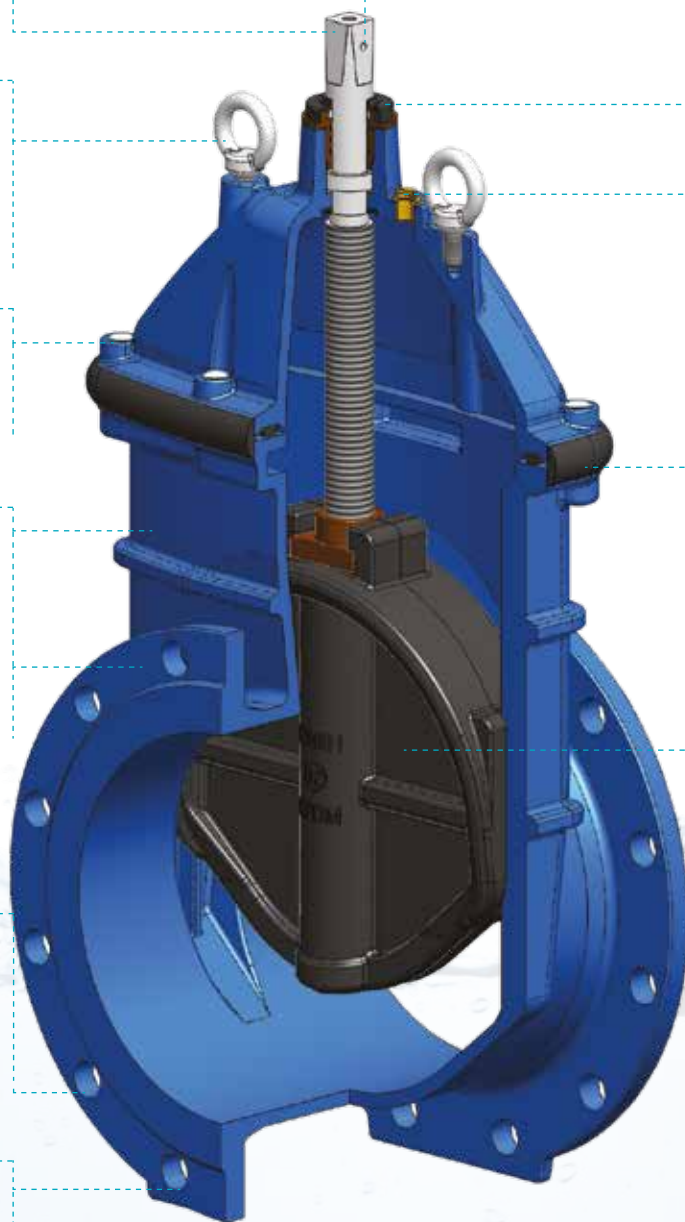

À partir du DN350, nous recommandons une installation de la vanne en position verticale pour son bon fonctionnement (voir page 205)
From DN350, we recommend to install the valve in upright position to get the full benefit of the resilient seat gate valve (see page 205)

VANNES OPERCULE CAOUTCHOUC

Les vannes opercules caoutchouc sont des vannes à passage direct avec une opercule revêtue d'un élastomère. Elles sont particulièrement utilisées pour les réseaux d'eaux usées, d'adduction d'eau potable, d'irrigation et d'assainissement. Son corps, chapeau et volant sont en peinture époxy.
Nos vannes opercules caoutchouc sont PN10/PN16 jusqu'au DN600 !

RESILIENT SEAT GATE VALVES

Resilient seat gate valves are gate valves with an elastomer lined wedge. They are especially used for wastewater, drinking water supply and irrigation. Body, bonnet and handwheel are epoxy coated.
OUR RESILIENT SEAT GATE VALVE ARE PN10/PN16 up to DN600!



VANNES À OPERCULE CAOUTCHOUC - SÉRIE COURTE
RESILIENT SEAT GATE VALVES - SHORT PATTERN

VOC4241C-00EP

Série courte F4 à volant | F4 short pattern with handwheel

Vanne à opercule caoutchouc F4 à volant
F4 Resilient seat gate valve with handwheel



Corps et chapeau : Fonte ductile EN-GJS-500-7 (GGG50)
Opercule : Fonte ductile revêtue EPDM
Volant : Fonte ductile EN-GJS-500-7 (GGG50)
Raccordement : Brides PN10/16
Pression de service : 16 bar
Température de service : +80°C
Fermeture sens horaire
Commande : Volant fonte ductile EN-GJS-500-7 (GGG50)
Tige non montante

Body & bonnet: Ductile iron EN-GJS-500-7 (GGG50)
Wedge: Ductile iron EPDM coated
Handwheel: Ductile iron EN-GJS-500-7 (GGG50)
Connection: Flanged PN10/16
Working pressure: 16 bar
Working temperature: +80°C
Clockwise to close
Operation: Ductile iron EN-GJS-500-7 (GGG50) handwheel
Non-rising stem

DN		L (mm)	Kg	Ref.
mm	inch			
40	1 1/2"	140	10	VOC4241C-00EP0040
50	2"	150	10,6	VOC4241C-00EP0050
60	2 1/4"	170	12,5	VOC4241C-00EP0065
65	2 1/2"	170	12,5	VOC4241C-00EP0065
80	3"	180	13,8	VOC4241C-00EP0080
100	4"	190	18	VOC4241C-00EP0100
125	5"	200	22	VOC4241C-00EP0125
150	6"	210	31,9	VOC4241C-00EP0150
200	8"	230	54,5	VOC4241C-00EP0200
250	10"	250	75,5	VOC4241C-00EP0250
300	12"	270	110	VOC4241C-00EP0300
350	14"	290	158	VOC4241C-00EP0350
400	16"	310	201	VOC4241C-00EP0400

DN50 ➔ 400 :



DN40 ➔ 400 :



Nos vannes opercule se montent entre PN10/PN16 jusqu'au DN600
Standard flange drilling PN10 / PN16 up to DN600

VOC4241C-08EP

Série courte F4 à réducteur | F4 short pattern with gearbox

Vanne à opercule caoutchouc F4 à réducteur
F4 Resilient seat gate valve with gearbox



Corps et chapeau : Fonte ductile EN-GJS-500-7 (GGG50)
Opercule : Fonte ductile revêtue EPDM
Raccordement : Brides PN10/16
Pression de service : 16 bar
Température de service : +80°C
Fermeture sens horaire
Commande : Réducteur motorisable à volant
Tige non montante

Body & bonnet: Ductile iron EN-GJS-500-7 (GGG50)
Wedge: Ductile iron EPDM coated
Connection: Flanged PN10/16
Working pressure: 16 bar
Working temperature: +80°C
Clockwise to close
Operation: Actuated gearbox with handwheel
Non-rising stem

DN		L (mm)	Kg	Ref.
mm	inch			
450	18"	330	310	VOC4241C-08EP0450
500	20"	350	400	VOC4241C-08EP0500
600	24"	390	610	VOC4241C-08EP0600



Nos vannes opercule se montent entre PN10/PN16 jusqu'au DN600
Standard flange drilling PN10 / PN16 up to DN600

EN OPTION | OPTION

Boitier de fin de course complet | Limit switch kit :
(300200043) p.195

VOC4241AP-08 | VOC424116AP-08

Série courte F4 à réducteur | F4 short pattern with gearbox

Vanne à opercule caoutchouc F4 à réducteur
F4 Resilient seat gate valve with gearbox



Corps et chapeau : Fonte ductile EN-GJS-500-7 (GGG50)
Opercule : Fonte ductile revêtue EPDM
Raccordement : Brides PN10 ou PN16
Pression de service : 10 bar
Température de service : +80°C
Fermeture sens horaire
Commande : Réducteur motorisable à volant IP67
Tige non montante

Body & bonnet: Ductile iron EN-GJS-500-7 (GGG50)
Wedge: Ductile iron EPDM coated
Connection: Flanged PN10 or PN16
Working pressure: 10 bar
Working temperature: +80°C
Clockwise to close
Operation: Actuated gearbox with handwheel IP67
Non-rising stem

DN		L (mm)	Kg	PN	Ref.
mm	inch				
700	28"	430	960	10	VOC4241AP-08EP0700
				16	VOC424116AP-08EP0700
800	32"	470	1250	10	VOC4241AP-08EP0800
				16	VOC424116AP-08EP0800
900	36"	510	1875	10	VOC4241AP-08EP0900
				16	VOC424116AP-08EP0900
1000	40"	550	3395	10	VOC4241AP-08EP1000
				16	VOC424116AP-08EP1000
1200	48"	630	4600	10	VOC4241AP-08EP1200
				16	VOC424116AP-08EP1200

DN700 ➔ 1000 :



EN OPTION | OPTION

Boitier de fin de course complet
Limit switch kit p.195
DN450-1000 (300200043)
DN1200 (300200044)



Nous contacter pour tout montage sur tuyauterie verticale ou fortement inclinée. Voir conseils page 205.
Contact us for mounting on vertical or steeply inclined piping. See the technical notes page 205.

VOC4241C-051EP

Série courte F4 à carré | F4 short pattern with square cap

Vanne à opercule caoutchouc F4 à carré

F4 Resilient seat gate valve with square cap



Corps et chapeau : Fonte ductile EN-GJS-500-7 (GGG50)
 Opercule : Fonte ductile revêtue EPDM
 Raccordement : Brides PN10/16
 Pression de service : 16 bar
 Température de service : +80°C
 Fermeture sens horaire
 Commande : A carré
 Tige non montante

Body & bonnet: Ductile iron EN-GJS-500-7 (GGG50)
 Wedge: Ductile iron EPDM coated
 Connection: Flanged PN10/16
 Working pressure: 16 bar
 Working temperature: +80°C
 Clockwise to close
 Operation: Square cap
 Non-rising stem

DN		L (mm)	Kg	Ref.
mm	inch			
40	1"1/2	140	9,5	VOC4241C-051EP0040
50	2"	150	10,1	VOC4241C-051EP0050
60	2"1/4	170	12	VOC4241C-051EP0065
65	2"1/2			
80	3"	180	13,3	VOC4241C-051EP0080
100	4"	190	17,5	VOC4241C-051EP0100
125	5"	200	21,5	VOC4241C-051EP0125
150	6"	210	31,4	VOC4241C-051EP0150
200	8"	230	54	VOC4241C-051EP0200
250	10"	250	75	VOC4241C-051EP0250
300	12"	270	109,5	VOC4241C-051EP0300
350	14"	290	157,5	VOC4241C-051EP0350
400	16"	310	200,5	VOC4241C-051EP0400

Pour tout DN supérieur, nous consulter
 Contact us for larger DN

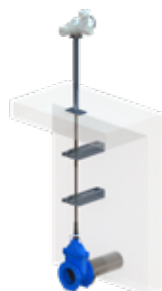

DN50 ➔ 400 :



DN40 ➔ 400 :



Vanne adaptée pour montage enterré ou sur colonnette droite et murale (du DN50 au DN200, au-delà nous consulter). Voir pages 200-201
 Valve adapted for underground or column and wall installations (DN50 to DN200, contact us for larger DN). See pages 200-201

VOC4241-00NI | VOC424110-00NI | VOC424116-00NI

Série courte F4 NBR | NBR F4 short pattern

Vanne à opercule caoutchouc F4 NBR à volant

F4 Resilient seat gate valve NBR with handwheel



Corps et chapeau : Fonte ductile EN-GJS-500-7 (GGG50)
 Opercule : Fonte ductile revêtue NBR
 Raccordement : A brides
 DN40-150 : PN10/16
 DN200-300 : PN10 ou PN16
 Pression de service : 16 bar
 Température de service : -10°C/+70°C
 Fermeture sens horaire
 Commande : Volant fonte ductile EN-GJS-500-7 (GGG50)
 Tige non montante

Body & bonnet: Ductile iron EN-GJS-500-7 (GGG50)
 Wedge: NBR-coated ductile iron
 Connection: Flanged
 DN40-150 : PN10/16
 DN200-300 : PN10 or PN16
 Working pressure: 16 bar
 Working temperature: -10°C/+70°C
 Clockwise to close
 Operation: Ductile iron EN-GJS-500-7 (GGG50) handwheel
 Non-rising stem

DN		L (mm)	Kg	PN	Ref.
mm	inch				
40	1"1/2	140	7,37	10/16	VOC4241-00NI0040
50	2"	150	8,56	10/16	VOC4241-00NI0050
65	2"1/2	170	11,30	10/16	VOC4241-00NI0065
80	3"	180	14	10/16	VOC4241-00NI0080
100	4"	190	19,90	10/16	VOC4241-00NI0100
125	5"	200	24,20	10/16	VOC4241-00NI0125
150	6"	210	31,80	10/16	VOC4241-00NI0150
200	8"	230	49,40	10/16	VOC424110-00NI0200 VOC424116-00NI0200
250	10"	250	84,70	10/16	VOC424110-00NI0250 VOC424116-00NI0250
300	12"	270	106	10/16	VOC424110-00NI0300 VOC424116-00NI0300

VOC4251C-00

Série courte F4 PN25 | PN25 F4 short pattern

Vanne à opercule caoutchouc F4 - tige non montante - PN25

Resilient seat gate valve - non-rising stem - PN25



Corps et chapeau : Fonte ductile EN-GJS-500-7 (GGG50)
 Opercule : Fonte ductile GGG 50 revêtue EPDM
 Raccordement : A brides PN25
 Pression de service max : 25 bar
 Température max : +80°C
 Fermeture sens horaire
 Commande : Volant fonte ductile EN-GJS-500-7 (GGG50)
 Tige non montante

Body & bonnet: Ductile iron EN-GJS-500-7 (GGG50)
 Wedge: EPDM coated ductile iron GGG50
 Connection: Flanges PN25
 Working pressure max: 25 bar
 Max Working temperature: +80°C
 Clockwise to close
 Operation : Ductile iron EN-GJS-500-7 (GGG50) handwheel
 Non-rising stem

DN		L (mm)	Kg	Ref.
mm	inch			
40	1"1/2	140	8	VOC4251C-00EP0040
50	2"	150	10	VOC4251C-00EP0050
65	2"1/2	170	12	VOC4251C-00EP0065
80	3"	180	16	VOC4251C-00EP0080
100	4"	190	22	VOC4251C-00EP0100
125	5"	200	32	VOC4251C-00EP0125
150	6"	210	41	VOC4251C-00EP0150
200	8"	230	72	VOC4251C-00EP0200
250	10"	250	101	VOC4251C-00EP0250
300	12"	270	155	VOC4251C-00EP0300

VOC4241CASA-00EP

Série courte F4 ASA 150 | ASA 150 F4 short pattern

Vanne à opercule caoutchouc F4 à volant ASA 150

F4 Resilient seat gate valve with handwheel - ASA 150



Corps et chapeau : Fonte ductile EN-GJS-500-7 (GGG50)

Opercule : Fonte ductile revêtue EPDM

Raccordement : A brides ASA 150LBS

Pression de service : 16 bar

Température de service : +80°C

Fermeture sens horaire

Commande : Volant fonte ductile EN-GJS-500-7 (GGG50)

Tige non montante

Body & bonnet: Ductile iron EN-GJS-500-7 (GGG50)

Wedge: Ductile iron EPDM coated

Connection: Flanged ASA 150LBS

Working pressure: 16 bar

Working temperature: +80°C

Clockwise to close

Operation : Ductile iron EN-GJS-500-7 (GGG50) handwheel

Non-rising stem

DN		L (mm)	Kg	Ref.
mm	inch			
40	1 1/2	140	10	VOC4241CASA-00EP0040
50	2"	150	10,6	VOC4241CASA-00EP0050
60	2 1/4	170	12,5	VOC4241CASA-00EP0065
65	2 1/2	170	12,5	VOC4241CASA-00EP0065
80	3"	180	13,8	VOC4241CASA-00EP0080
100	4"	190	18	VOC4241CASA-00EP0100
125	5"	200	22	VOC4241CASA-00EP0125
150	6"	210	31,9	VOC4241CASA-00EP0150
200	8"	230	54,5	VOC4241CASA-00EP0200
250	10"	250	75,5	VOC4241CASA-00EP0250
300	12"	270	110	VOC4241CASA-00EP0300
350	14"	290	158	VOC4241CASA-00EP0350
400	16"	310	201	VOC4241CASA-00EP0400

VOC4241CASA-08EP

Série courte F4 ASA 150 à réducteur | ASA 150 F4 short pattern with gearbox

Vanne à opercule caoutchouc F4 à réducteur ASA 150

F4 Resilient seat gate valve with gearbox - ASA 150



Corps et chapeau : Fonte ductile EN-GJS-500-7 (GGG50)

Opercule : Fonte ductile revêtue EPDM

Raccordement : A brides ASA 150LBS

Pression de service : 16 bar

Température de service : +80°C

Fermeture sens horaire

Commande : Réducteur motorisable à volant

Tige non montante

Body & bonnet: Ductile iron EN-GJS-500-7 (GGG50)

Wedge: Ductile iron EPDM coated

Operation: Actuated gearbox with handwheel

Working pressure: 16 bar

Working temperature: +80°C

Connection: Flanged ASA 150LBS

Clockwise to close

Operation: Actuated gearbox with handwheel

Non-rising stem

DN		L (mm)	Kg	Ref.
mm	inch			
450	18"	330	310	VOC4241CASA-08EP0450
500	20"	350	400	VOC4241CASA-08EP0500
600	24"	390	610	VOC4241CASA-08EP0600

EN OPTION | OPTION

Boitier de fin de course complet
Limit switch kit (300200043) p.195

VOC4241C2C

Série courte F4 avec contact mécanique | F4 short pattern with mechanical limit switches

Vanne à opercule caoutchouc F4 - tige non montante - avec kit de 2 contacts mécaniques - PN16
 F4 Resilient seat gate valve - non-rising stem - PN16 with kit of 2 mechanical limit switches



Corps et chapeau :
 Fonte ductile EN-GJS-500-7 (GGG50)
Opercule : Fonte ductile GGG 50 revêtue EPDM
Raccordement : A brides PN10/16
Pression de service max : 16 bar
Température max : +80°C
Fermeture sens horaire
 Kit de 2 contacts mécaniques à galet type
 XCKM 115 Schneider / Telemecanique
 Position ouverture/fermeture

Body & bonnet:
 Ductile iron EN-GJS-500-7 (GGG50)
Wedge: EPDM coated ductile iron GGG50
Connection: Flanges PN10/16
Working pressure max: 16 bar
Max Working temperature: +80°C
Clockwise to close
 2 mechanical limit switches Schneider /
 Telemecanique XCKM115 type
 Open and closed position

DN		L (mm)	Kg	Ref.
mm	inch			
40	1 1/2	140	11,15	VOC4241C2C-00EP0040
50	2"	150	11,31	VOC4241C2C-00EP0050
65	2 1/2	170	13,73	VOC4241C2C-00EP0065
80	3"	180	15,73	VOC4241C2C-00EP0080
100	4"	190	18,63	VOC4241C2C-00EP0100
125	5"	200	26,54	VOC4241C2C-00EP0125
150	6"	210	51,70	VOC4241C2C-00EP0150
200	8"	230	55	VOC4241C2C-00EP0200
250	10"	250	83	VOC4241C2C-00EP0250
300	12"	270	118	VOC4241C2C-00EP0300
350	14"	290	184	VOC4241C2C-00EP0350
400	16"	310	230	VOC4241C2C-00EP0400

DN50 ➔ 400 :



DN40 ➔ 400 :



Equipé de 2 contacts mécaniques de fin de course et 1 indicateur de position
 With two mechanical switches and a position indicator

VOC4241CM

Série courte F4 avec embase ISO | F4 short pattern with ISO plate

Vanne à opercule caoutchouc F4 - tige non montante - avec embase ISO pour motorisation électrique - PN16
 F4 Resilient seat gate valve - non-rising stem - PN16 with ISO mounting plate for electric actuator



Corps et chapeau : Fonte ductile EN-GJS-500-7 (GGG50)
Opercule : Fonte ductile GGG50 revêtue EPDM ACS
Raccordement : A brides PN10/16 double perçage
Pression de service max : 16 bar
Température de service : +80°C
Fermeture sens horaire

Body & bonnet: Ductile iron GGG50
Wedge: ACS EPDM coated ductile iron GGG50
Connection: Flanges PN10/16
Working pressure max: 16 bar
Working temperature: +80°C
Clockwise to close

DN		L (mm)	Kg	Ref.
mm	inch			
40	1 1/2	140	11	VOC4241CM-00EP0040
50	2"	150	12	VOC4241CM-00EP0050
65	2 1/2	170	15	VOC4241CM-00EP0065
80	3"	180	18	VOC4241CM-00EP0080
100	4"	190	23	VOC4241CM-00EP0100
125	5"	200	36	VOC4241CM-00EP0125
150	6"	210	44	VOC4241CM-00EP0150
200	8"	230	68	VOC4241CM-00EP0200
250	10"	250	96	VOC4241CM-00EP0250
300	12"	270	140	VOC4241CM-00EP0300
350	14"	290	170	VOC4241CM-00EP0350
400	16"	310	222	VOC4241CM-00EP0400

DN50 ➔ 400 :



DN40 ➔ 400 :



VOC4241C-C08CEP | VOC4201C-C08CEP

Série courte F4 avec CFC | F4 short pattern with WSH

Vanne à opercule caoutchouc à brides avec kit boîtier fin de course AUMA WSH 14.2 - PN10/16
 Resilient seat gate valve with AUMA WSH 14.2 limit switch device



Corps et chapeau :
 Fonte ductile EN-GJS-500-7 (GGG50)
Opercule : Fonte ductile GGG50 revêtue EPDM
Raccordement : A brides PN10/16
 PN16 à partir DN700
Pression de service max : 16 bar
Température max : +80°C
Fermeture sens horaire
 Tige non montante
 Réducteur motorisable avec bloc contacts fin de course AUMA WSH14.2 à volant
 Avec une vis de purge

Body & bonnet:
 Ductile iron EN-GJS-500-7 (GGG50)
Wedge: EPDM coated ductile iron GGG50
Connection: Flanges PN10/16
 PN16 from DN700
Working pressure max: 16 bar
Max Working temperature: +80°C
Clockwise to close
 Non rising stem
 Gearbox with top flange ISO equipped with limit switch AUMA WSH14.2 with handwheel
 With drain plugs

DN		L (mm)	Kg	PN10/16	
mm	inch			Ref.	Ref.
450	18"	330	326	VOC4241C-C08CEP0450	
500	20"	350	416	VOC4241C-C08CEP0500	
600	24"	390	626	VOC4241C-C08CEP0600	

DN		L (mm)	Kg	PN10	PN16
mm	inch			Ref.	Ref.
700	28"	960	976	VOC4201C-C08CEP0700	VOC4241C-C08CEP0700
800	32"	1250	1266	VOC4201C-C08CEP0800	VOC4241C-C08CEP0800
900	36"	1875	1891	VOC4201C-C08CEP0900	VOC4241C-C08CEP0900
1000	40"	3395	3411	VOC4201C-C08CEP1000	VOC4241C-C08CEP1000
1200	48"	4600	4622	VOC4201C-C08CEP1200	VOC4241C-C08CEP1200

DN450 ➔ 600 :



DN450 ➔ 1200 :



BOITIER FIN DE COURSE AUMA

Kit CFC Auma pour VOC TECOFI

AUMA limit switches KIT for TECOFI resilient seat gate valve



Composé de :
 - 2 fin de course (WSH 14.2) 1 ouverture / 1 fermeture
 . IP68
 . Platine F14
 . Résistance de chauffe
 - Vis, rondelle

Comprised of :
 - 2 limit switches (WSH 14.2) 1 open / 1 close
 . IP68
 . F14
 . Heat resistor
 - Screws, spring lock washer

DN		Kg	Ref.
mm	inch		
450-1000	18" - 40"	16	300200043
1200	48"	22	300200044



Se monte directement sur le réducteur de VOC version -08
 Mounted directly on the VOC version -08

VOC4241CM-U04 | VOC4241C-U04 Moteur électrique AUMA | AUMA electric actuator

Vanne à opercule caoutchouc avec moteur électrique AUMA - PN16

Resilient seat gate valve with AUMA electric actuator - PN16



Corps et chapeau : Fonte ductile EN-GJS-500-7 (GGG50)
Opercule : Fonte ductile GGG50 revêtue EPDM ACS
Raccordement : A brides PN10/16
Pression de service max : 16 bar jusqu'au DN600 (au-delà voir tableau)
Température de service : -10°C/+80°C
Fermeture sens horaire
Moteur électrique AUMA 3 phases 400V/50Hz On/Off

Body & bonnet: Ductile iron EN-GJS-500-7 (GGG50)
Wedge: ACS EPDM coated ductile iron GGG50
Connection: Flanges PN10/16
Working pressure max: 16 bar up to DN600 (see table for larger DN)
Max Working temperature: -10°C/+80°C
Clockwise to close
AUMA electric actuator 3-phase 400V/50Hz On/Off

DN50 ➔ 400 :



DN40 ➔ 600 :



DN		L (mm)	Kg	Ref.
mm	inch			
40	1 1/2	140	39	VOC4241CM-U04EP0040
50	2"	150	40	VOC4241CM-U04EP0050
65	2 1/2	170	43	VOC4241CM-U04EP0065
80	3"	180	46	VOC4241CM-U04EP0080
100	4"	190	51	VOC4241CM-U04EP0100
125	5"	200	64	VOC4241CM-U04EP0125
150	6"	210	72	VOC4241CM-U04EP0150
200	8"	230	116	VOC4241CM-U04EP0200
250	10"	250	144	VOC4241CM-U04EP0250
300	12"	270	193	VOC4241CM-U04EP0300
350	14"	290	223	VOC4241CM-U04EP0350
400	16"	310	275	VOC4241CM-U04EP0400
450	18"	330	358	VOC4241C-U04EP0450
500	20"	350	448	VOC4241C-U04EP0500
600	24"	390	658	VOC4241C-U04EP0600

DN		L (mm)	Kg	PN	Ref.
mm	inch				
700	28"	430	1008	10	VOC4241A-U04EP0700
				16	VOC424116A-U04EP0700
800	32"	470	1298	10	VOC4241A-U04EP0800
				16	VOC424116A-U04EP0800
900	36"	510	1923	10	VOC4241A-U04EP0900
				16	VOC424116A-U04EP0900
1000	40"	550	3448	10	VOC4241A-U04EP1000
				16	VOC424116A-U04EP1000
1200	48"	630	-	10	VOC4241A-U04EP1200
				16	VOC424116A-U04EP1200

U04

Kit moteur électrique AUMA | AUMA electric actuator kit

Kit motorisation Auma 3 phases 400V/50Hz On/Off

Kit Auma electric actuator 3-phase 400V/50Hz On/Off



Moteur équipé de :
 - 2 contacts fin de course
 - 1 résistance de chauffe
 - 2 limiteurs de couple
Commande manuelle de secours
Indicateur visuel de position
Protection IP68

Actuator equipped:
 - 2 limit switches
 - 1 heat resistor
 - 2 torque limit switches
Emergency handwheel
Visual position indicator
IP68 protection

DN		Moteur Actuator
mm	inch	
40-65	1 1/2 - 2 1/2	VOCMOTEELEC-SA07.61
80-150	3"-4"	VOCMOTEELEC-SA10.21
200-250	4"-10"	VOCMOTEELEC-SA14.21
300-400	5"-16"	VOCMOTEELEC-SA14.61
450	18"	
500	20"	SA142U04B4D32TOR90T
600	24"	

DN		PN	Moteur Actuator
mm	inch		
700-1000	28"-40"	10	SA142U04B4D32TOR125T
1200	48"	10	SA146U04B4D40TOR180T
700-900	28"-36"	16	SA142U04B4D32TOR125T
1000	40"	16	SA146U04B4D32TOR125T
1200	48"	16	SA146U04B4D40TOR180T

VOC4241CM-B04

Moteur électrique BERNARD CONTROLS | BERNARD CONTROLS electric actuator

Vanne à opercule caoutchouc - avec moteur électrique BERNARD CONTROLS - PN16

Resilient seat gate valve - PN16 - with BERNARD CONTROLS electric actuator



ACS



Corps et chapeau : Fonte ductile EN-GJS-500-7 (GGG50)
 Opercule : Fonte ductile GGG 50 revêtuée EPDM ACS
 Raccordement : A brides PN10/16
 Pression de service max : 16 bar jusqu'au DN600 (au-delà voir tableau)
 Température de service : -10°C/+80°C
 Fermeture sens horaire
 Moteur électrique triphasé 400 volts 50 Hz On/Off

Body & bonnet: Ductile iron EN-GJS-500-7 (GGG50)
 Wedge: ACS EPDM coated ductile iron GGG50
 Connection: Flanges PN10/16
 Working pressure max: 16 bar up to DN600 (see table for larger DN)
 Max Working temperature: -10°C/+80°C
 Clockwise to close
 Electric actuator 3P 400 volts 50Hz On/Off



Sur demande / On request

DN		L (mm)	Kg	Ref.
mm	inch			
50	2"	150	60	VOC4241CM-B04EP0050
65	2 1/2"	170	63	VOC4241CM-B04EP0065
80	3"	180	66	VOC4241CM-B04EP0080
100	4"	190	71	VOC4241CM-B04EP0100
125	5"	200	84	VOC4241CM-B04EP0125
150	6"	210	92	VOC4241CM-B04EP0150
200	8"	230	132	VOC4241CM-B04EP0200
250	10"	250	160	VOC4241CM-B04EP0250
300	12"	270	206	VOC4241CM-B04EP0300
350	14"	290	236	VOC4241CM-B04EP0350
400	16"	310	288	VOC4241CM-B04EP0400

DN		L (mm)	Kg	Ref.
mm	inch			
450	18"	330	374	VOC4241C-B04EP0450
500	20"	350	464	VOC4241C-B04EP0500
600	24"	390	674	VOC4241C-B04EP0600

DN		L (mm)	Kg	PN	Ref.
mm	inch				
700	28"	430	1024	10	VOC4241A-B04EP0700
				16	VOC424116A-B04EP0700
800	32"	470	1314	10	VOC4241A-B04EP0800
				16	VOC424116A-B04EP0800
900	36"	510	1939	10	VOC4241A-B04EP0900
				16	VOC424116A-B04EP0900
1000	40"	550	3461	10	VOC4241A-B04EP1000
				16	VOC424116A-B04EP1000
1200	48"	630	4666	10	VOC4241A-B04EP1200
				16	VOC424116A-B04EP1200

B04

Kit moteur électrique BERNARD CONTROLS | BERNARD CONTROLS actuator kit

Kit motorisation BERNARD CONTROLS TRI 400V/50Hz On/Off

Kit electric actuator BERNARD CONTROLS TRI 400V/50Hz On/Off



Moteur équipé de :
 - 4 contacts fin de course
 - 1 résistance de chauffe
 - 2 limiteurs de couple
 Commande manuelle de secours par volant
 Indicateur de position
 Protection IP68

Actuator equipped with:
 - 4 limit switches
 - 1 heat resistor
 - 2 torque limit switches
 Emergency handwheel
 Position indicator
 IP68 protection

DN		Moteur Actuator	Ref. KIT
mm	inch		
50-65	2"-2 1/2"	AT6	300200289
80-150	3"-6"	AT14	300200290
200	8"	AT25	300200291
250	10"		
300	12"	AT50	300200292
350	14"		
400	16"		
450-600	18"-24"	AT25	300200345

Modèle AT6-14 gamme Switch
 Model AT6-14 range Switch

	DN		Moteur Actuator	Ref. KIT
	mm	inch		
PN10	700	28"	AT14	300210020
	800-1000	32" - 40"	AT25	300210023
	1200	48"	AT50	300210024
PN16	700-900	28" - 36"	AT25	300210023
	1000	40"	AT50	300210025
	1200	48"	AT50	300210024



VANNES À OPERCULE CAOUTCHOUC - SÉRIE LONGUE RESILIENT SEAT GATE VALVES - LONG PATTERN

VOC4240C-00EP

Série longue F5 | F5 Long pattern

Vanne à opercule caoutchouc F5 à volant fermeture sens horaire

F5 Resilient seat gate valve with handwheel clockwise to close



Corps et chapeau : Fonte ductile EN-GJS-500-7 (GGG50)
Opercule : Fonte ductile revêtue EPDM
Raccordement : Brides PN10/16
Pression de service : 16 bar
Température de service : +80°C
Fermeture sens horaire
Commande : Volant
Tige non montante

Body & bonnet : Ductile iron EN-GJS-500-7 (GGG50)
Wedge : Ductile iron EPDM coated
Connection : Flanged PN10/16
Working pressure : 16 bar
Working temperature : +80°C
Operation : Handwheel
Non-rising stem

DN50 → 400 :



DN40 → 400 :



DN		L (mm)	Kg	Ref.
mm	inch			
40	1"1/2	240	11,2	VOC4240C-00EP0040
50	2"	250	11,8	VOC4240C-00EP0050
60	2"1/4	270	14,4	VOC4240C-00EP0065
65	2"1/2			
80	3"	280	15,2	VOC4240C-00EP0080
100	4"	300	20,2	VOC4240C-00EP0100
125	5"	325	33	VOC4240C-00EP0125
150	6"	350	35	VOC4240C-00EP0150
200	8"	400	64	VOC4240C-00EP0200
250	10"	450	87	VOC4240C-00EP0250
300	12"	500	147	VOC4240C-00EP0300
350	14"	-	-	VOC4240C-00EP0350
400	16"	600	251	VOC4240C-00EP0400

VOC4240C-00AHEP

Série longue F5 | F5 Long pattern

Vanne à opercule caoutchouc F5 à volant fermeture sens anti horaire

F5 Resilient seat gate valve with handwheel counterclockwise to close



Corps et chapeau : Fonte ductile wEN-GJS-500-7 (GGG50)
Opercule : Fonte ductile revêtue EPDM
Raccordement : Brides PN10/16
Pression de service : 16 bar
Température de service : +80°C
Fermeture sens anti horaire
Commande : Volant
Tige non montante

Body & bonnet : Ductile iron EN-GJS-500-7 (GGG50)
Wedge : Ductile iron EPDM coated
Connection : Flanged PN10/16
Working pressure : 16 bar
Working temperature : +80°C
Anti-counterclockwise close
Operation : Handwheel
Non-rising stem



DN		L (mm)	Kg	Ref.
mm	inch			
40	1"1/2	240	11,2	VOC4240C-00AHEP0040
50	2"	250	11,8	VOC4240C-00AHEP0050
60	2"1/4	270	14,4	VOC4240C-00AHEP0065
65	2"1/2			
80	3"	280	15,2	VOC4240C-00AHEP0080
100	4"	300	20,2	VOC4240C-00AHEP0100
125	5"	325	33	VOC4240C-00AHEP0125
150	6"	350	35	VOC4240C-00AHEP0150
200	8"	400	64	VOC4240C-00AHEP0200
250	10"	450	87	VOC4240C-00AHEP0250
300	12"	500	147	VOC4240C-00AHEP0300
350	14"	-	-	VOC4240C-00AHEP0350
400	16"	600	251	VOC4240C-00AHEP0400

VOC4240C-05AHEP

Série longue F5 | F5 Long pattern

Vanne à opercule caoutchouc F5 à carré fermeture sens anti horaire

F5 Resilient seat gate valve with square cap counterclockwise to close



Corps et chapeau : Fonte ductile EN-GJS-500-7 (GGG50)
Opercule : Fonte ductile revêtue EPDM
Raccordement : Brides PN10/16
Pression de service : 16 bar
Température de service : +80°C
Fermeture sens anti horaire
Commande : Carré de manœuvre

Body & bonnet : Ductile iron EN-GJS-500-7 (GGG50)
Wedge : Ductile iron EPDM coated
Connection : Flanged PN10/16
Working pressure : 16 bar
Working temperature : +80°C
Anti-clockwise to close
Operating : Square



DN		L (mm)	Kg	Ref.
mm	inch			
40	1"1/2	240	11	VOC4240C-05AHEP0040
50	2"	250	11,3	VOC4240C-05AHEP0050
60	2"1/4	270	19,9	VOC4240C-05AHEP0065
65	2"1/2			
80	3"	280	14,7	VOC4240C-05AHEP0080
100	4"	300	19,7	VOC4240C-05AHEP0100
125	5"	325	32,5	VOC4240C-05AHEP0125
150	6"	350	34,5	VOC4240C-05AHEP0150
200	8"	400	63,5	VOC4240C-05AHEP0200
250	10"	450	86,5	VOC4240C-05AHEP0250
300	12"	500	146,5	VOC4240C-05AHEP0300
350	14"	-	-	VOC4240C-05AHEP0350
400	16"	600	250,5	VOC4240C-05AHEP0400



KIT POUR VANNES À OPERCULE CAOUTCHOUC ENTERRÉES
KIT FOR BURIED RESILIENT SEAT GATE VALVES

VANNE PASSAGE DIRECT
GATE VALVE

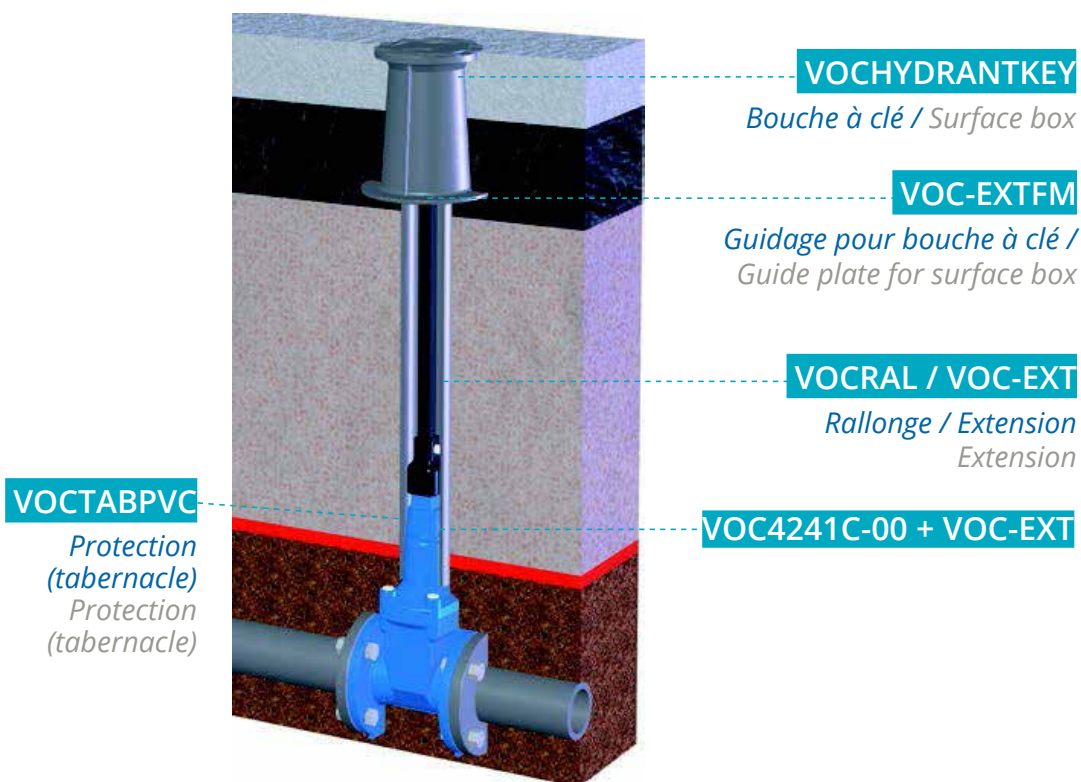

CARRÉ DE MANŒUVRE | SQUARE ADAPTOR

Carré de manœuvre pour vanne à opercule caoutchouc
 Square adaptor for resilient seat gate valve



Matière DN40-400 : Fonte GG25 (30*30)
 Matière DN450-600 : Inox 304
 Dimensions : 30*30

Material DN40-400 : Cast iron GG25 (30*30)
 Material DN450-600: Stainless Steel 304
 Dimensions: 30*30

	DN		Ref.
	mm	inch	
	40-50	1"1/2 - 2"	VOCCMC-00400050
	65-80	2"1/2 - 3"	VOCCMC-00650080
	100-150	4" - 6"	VOCCMC-01000150
	200	8"	VOCCMC-0200
	250-400	10" - 16"	VOCCMC-02500400
	450-600	18" - 24"	VOCCMC-04500600

Convient pour toute la série VOC-C
 Adapted for all of the VOC-C serie

RALLONGE | EXTENSION

Rallonge fixe universelle
 Universal stem extension



Matière : Acier
 Montage avec VOC4241C-051

Material: Steel
 With VOC4241C-051

L	Ref.
1 M	VOCRAL-1.0ML
1,5 M	VOCRAL-1.5ML
2 M	VOCRAL-2.0ML
3 M	VOCRAL-3.0ML

PROTECTION I PROTECTION

Tabernacle
Tabernacle



Matière : PVC

Material: PVC

Ref.	Prix / Price
VOCTABPVC	34,00€



À utiliser avec la rallonge télescopique pour protéger la vanne enterrée
To be used with the telescopic extension to protect the buried valve

EXTENSION I EXTENSION

Extension télescopique
Telescopic extension



Matière : Acier galvanisé
Tube : Plastique
Carré : Fonte ductile

Material: Galvanised steel
Tube: Plastic
Square: Ductile iron



Equipé du tube de protection
Equiped with the protective tube

DN	L (mm)		Ref.
	min	max	
40-150	450	700	VOC-EXTXS0040-0150
	650	1100	VOC-EXTS0040-0150
	980	1750	VOC-EXTM0040-0150
	1610	2900	VOC-EXTL0040-0150
200-400	450	700	VOC-EXTXS0200-0400
	660	1100	VOC-EXTS0200-0400
	1040	1750	VOC-EXTM0200-0400
	1620	2900	VOC-EXTL0200-0400



Ajouter la dimension H du passeport technique VOC4241C-00 à la côte L pour la distance du centre de la tuyauterie à la manœuvre.

Add the dimension H from the VOC4241C-00 technical sheet to the L for the distance of the pipe axis to the actuator.

GUIDAGE I GUIDE PLATE

Plateau de centrage pour bouche à clé
Guide plate for surface box



Matière : PP

Material: PP

Ref.

VOC-EXTFM

BOUCHE A CLE I SURFACE BOX

Bouche à clé
Surface box



Construction : Fonte

Construction: Cast iron

Modèle / Model	Ref.
Rond/Round	VOCHYDRANTKEY-01
Carré/Square	VOCHYDRANTKEY-02

CLE DE FONTAINIER I HYDRANT KEY

Clé de fontainier universelle
Universal hydrant key

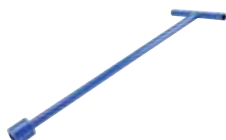

Matière : Acier
Carré : 30mm

Material: Steel
Square: 30mm



Avec embout universel pour carré de manœuvre
With universal end for operating square

L	Ref.
1M	VOCLEVWRENCH-1.0ML
1.5M	VOCLEVWRENCH-1.5ML
2M	VOCLEVWRENCH-2.0ML

KIT COLONNETTE DROITE POUR VOC*

PEDESTAL FLOOR MOUNTED KIT FOR RESILIENT SEAT GATE VALVES*

À VOLANT | WITH HANDWHEEL

VOL1A / VOL2A

GUICOLA

Plaque de guidage
Guide plate

COL3A-F10

Colonne
Pedestal

U04 AUMA

F10AU1A / F14AU1A

VPADPTENMOT-02000300

Entretoise de centrage à rajouter avec
F10AU1A
Spacer for actuator adaptation
to add to F10AU1A

COL3A-F10 / COL3A-F14

Colonne
Pedestal

EXT1A/EXT2A/EXT3A/EXT4A/
EXT5A

Rallonge / Extension

PAL2A/PAL3A

Palier de guidage
Guide plate

ADAPTCARRÉ1

VANNE À OPERCULE
CAOUTCHOUC

Resilient seat
gate valve



Kit à utiliser avec
la vanne à opercule
caoutchouc
(DN50 au 200, au-delà
nous consulter):
VOC4241C-051
Page 192

Kit to be used with
resilient seat gate valve
(DN50 to 200, contact us
for larger DN:
VOC4241C-051
Page 192

Représentation à titre indicatif (contre-bridés et tirants non représentés, ils sont obligatoires dans toutes installations).
Representation for reference only (counter flanges and tie rods not shown are required in all installations).

KIT COLONNETTE MURALE POUR VOC*

PEDESTAL WALL MOUNTED KIT FOR RESILIENT SEAT GATE VALVES*

À VOLANT | WITH HANDWHEEL



VOL1A / VOL2A

COL1A

Colonne
Pedestal

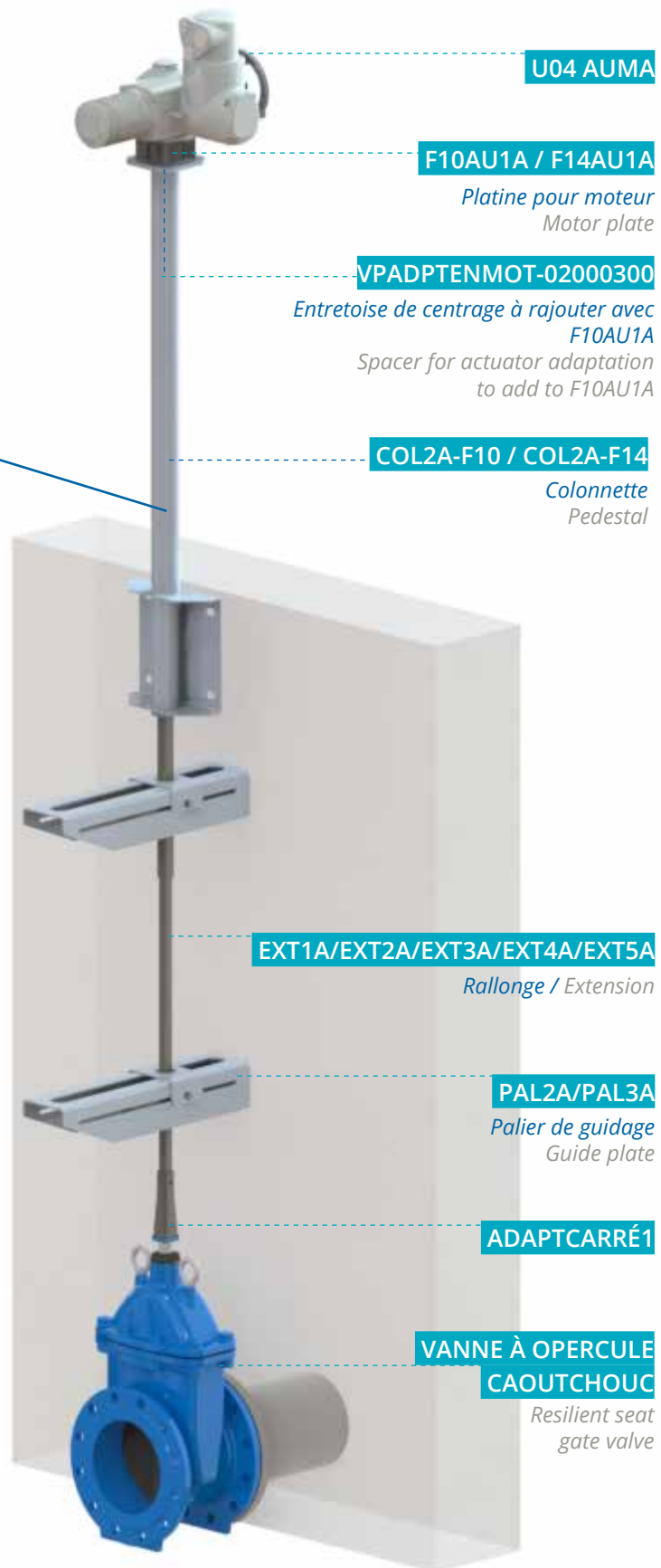

U04 AUMA

F10AU1A / F14AU1A

Platine pour moteur
Motor plate

VPADPTENMOT-02000300

Entretoise de centrage à rajouter avec
F10AU1A
Spacer for actuator adaptation
to add to F10AU1A

COL2A-F10 / COL2A-F14

Colonne
Pedestal

EXT1A/EXT2A/EXT3A/EXT4A/EXT5A

Rallonge / Extension

PAL2A/PAL3A

Palier de guidage
Guide plate

ADAPTCARRÉ1

VANNE À OPERCULE
CAOUTCHOUC

Resilient seat
gate valve



Kit à utiliser avec
la vanne à opercule
caoutchouc
(DN50 au 200, au-delà
nous consulter) :

VOC4241C-051

Page 192

Kit to be used with
resilient seat gate valves
(DN50 to 200, contact us
for larger DN:
VOC4241C-051

Page 192



La distance entre le mur et les colonnettes murales n'est pas réglable. Prévoir un déport avec le mur ou un système pour plaquer la colonnette à la bonne distance.
The distance between the wall and the wall column is not adjustable, provide an offset with the wall or a system to place the column at the right distance.

Représentation à titre indicatif (contre-brides et tirants non représentés, ils sont obligatoires dans toutes installations).
Representation for reference only (counter flanges and tie rods not shown are required in all installations).



TRINGLIERIES POUR MONTAGE SUR COLONNETTE LINKAGE FOR PEDESTAL MOUNTED

CARRE CONIQUE I SQUARE ADAPTOR

Pour adaptation de carré conique à rallonge EXT
Square 30x30 adaptor for EXT extension



Matière : Inox 304

Material: Stainless Steel 304

Ref.
ADAPTCARRE1

RALLONGE I EXTENSION

Rallonge télescopique
Telescopic extension



Matière : 316L

Material: 316L

Dimension (mm)	Ref.
800 - 1100	EXT1A
1100 - 1750	EXT2A
1750 - 3000	EXT3A
3000 - 5500	EXT4A
4000 - 8000	EXT5A

PALIER DE GUIDAGE I GUIDE PLATE

Palier de guidage fixe pour rallonge télescopique
Guide plate for telescopic extension EXT



Matière : Inox 316L

Material: Stainless Steel 316L

Dimension (mm)	Ref.
70-200	PAL2A
70-500	PAL3A



Mettre obligatoirement un palier tous les 2 mètres + un autre avant le passage dans la colonnette.
Place 1 guide plate every 2 meters of the extension + 1 guide plate just before the pedestal floor.

COLONNETTE I PEDESTAL

Colonnette pour vannes à opercule caoutchouc
Pedestal for resilient seat gate valve



- COL1A : pour commande par volant et fixation murale
- COL2A-F10 : pour commande motorisée (F10) et fixation murale
- COL2A-F14 : pour commande motorisée (F14) et fixation murale
- COL3A-F10 : pour commande motorisée (F10) et fixation au sol
- COL3A-F14 : pour commande motorisée (F14) et fixation au sol

Matière : Inox 304
Hauteur fixe : 900mm

Pedestal wall mounted for handwheel
Pedestal wall mounted for Auma actuator (F10)
Pedestal wall mounted for Auma actuator (F14)
Pedestal floor mounted for Auma actuator (F10)
Pedestal floor mounted for Auma actuator (F14)

Material: Stainless Steel 304
Fixed height: 900mm

Ref.
COL1A
COL2A-F10
COL2A-F14
COL3A-F10
COL3A-F14

1 2 3



PLAQUE DE GUIDAGE | GUIDE PLATE

Plaque de guidage pour colonnette fixation sol et commande par volant
Guide plate for pedestal floor mounted handwheel



Matière : POM

Material: POM

Ref.

GUICOLA



Permet de guider la rallonge
Used to guide the extension



A utiliser obligatoirement en cas de commande par volant sur colonnette COL3A-F10.
To use only with handwheel operation on pedestal COL3A-F10.

VOLANT | HANDWHEEL

Volant
Handwheel



Matière : Acier revêtu Epoxy
VOL1 : Diamètre 300mm
VOL2 : Diamètre 500mm

Material: Carbon Steel Epoxy coated
VOL1: Diameter 300mm
VOL2: Diameter 500mm

DN		Ref.
mm	inch	
40-150	2"-6"	VOL1A
200	8"	VOL2A

PLATINE ISO POUR MOTEUR | ISO TOP FLANGE FOR ACTUATOR

Platine pour moteur Auma montage sur EXT
Iso top Flange for Auma actuator



Matière : Acier
Platine : ISO5210
Pour montage sur colonnette (sur EXT)

Material: Steel
Top mounted flange: ISO5210
For assembly on column (on EXT)

Ref.

F10AU1A

F14AU1A



Pour accouplement entre colonnette et moteur Auma
Coupling between the column and the Auma actuator

ENTRETOISE DE CENTRAGE | SPACER FOR ACTUATOR ADAPTATION

Entretoise d'adaptation pour F10AU1
Adaptation for F10AU1



Matière : Inox
Pour montage sur colonnette

Material: Stainless steel
For assembly on column

Ref.

VPADPTENMOT-02000300

U04 - MOTEUR VOC - COLONNETTE COLONNETTE | AUMA ACTUATOR FOR VOC PEDESTAL MOUNTED

Motorisation Auma 3 phases 400V/50Hz On/Off
Auma actuator 3-phase 400V/50Hz On/Off



Moteur équipé de :
- 2 contacts fin de course
- 1 résistance de chauffe
- 2 limiteurs de couple
Commande manuelle de secours par volant
Indicateur visuel de position
Protection IP68

Actuator equipped:
- 2 limit switches
- 1 heat resistor
- 2 torque limit switches
Emergency handwheel
Visual position indicator
IP68 protection

DN		Ref.
mm	inch	
50-65	2"-2"1/2"	SA07.2-U04B1TOR22
80-150	3"-6"	SA10.2-U04B1TOR32
200	8"	SA14.2-U04B1TOR32

Non recommandé au-delà du DN200, couple important.
Not recommended for size DN200 and above, high torque.



VANNES OPERCULE CAOUTCHOUC RESILIENT SEAT GATE VALVES

GÉNÉRALITÉS

Si les vannes doivent être stockées en position ouverte, une protection doit être mise en place pour protéger les vannes du sable et de la boue. Un soin tout particulier doit être pris pour protéger l'opercule et le siège.

Avant montage des vannes opercule caoutchouc, bien vérifier l'encombrement entre brides. La robinetterie n'absorbera pas les écarts. Les déformations résultant de cette pratique peuvent entraîner des problèmes d'étanchéité, des difficultés de manœuvre et même des ruptures.

Les tuyauteries doivent être parfaitement alignées et leur supportage suffisamment dimensionné afin que les vannes ne supportent aucune contrainte extérieure.

Les vannes à opercule conviennent uniquement au fonctionnement ouvert/fermé. Un fonctionnement continu en position intermédiaire entraîne une plus grande usure, il doit être évité. Il convient d'employer d'autres versions de vannes spéciales pour le service de régulation prononcé.

Lors de la fermeture des vannes, ne jamais utiliser d'outil augmentant le couple exercé sur les volants (clé à volant ou rallonge). Cette pratique risque d'endommager les portées d'étanchéité.

La vanne devra être à la pression zéro et à la température ambiante avant n'importe quelle opération de maintenance.

GENERALITIES

If the valves are to be stored in the open for sometime, protection should be provided to keep the valves clear of sand and mud. Particular care should be taken to protect the wedge and the seat.

Before assembly of resilient seat gate valves, well to verify the dimensions between flanges. The valves will not absorb the distances. The deformations resulting from this practice can entail problems of waterproofness, difficulties of operation and even breaks.

The pipings must be perfectly aligned and their sized enough support so that valves support no outside.

Resilient seat gate valves are designed to operate either in the fully closed or open positions, if used in an intermediate position this will lead to increased wear and therefore reduced.

During the closure of valve never use a tool increasing the couple exercised on steering wheels (key with steering wheel or extension lead for example). This practice risks damaging the seat.

The valve should be at zero pressure and ambient temperature prior to any maintenance.





POSITIONS RECOMMANDÉES

- 1** DN40 à DN300 :
Vanne verticale, sur tuyauterie horizontale
Vanne horizontale, sur tuyauterie horizontale
Vanne horizontale, sur tuyauterie verticale
- 2** DN350 à DN600 :
Vanne verticale, sur tuyauterie horizontale
Vanne oblique possible jusqu'à 30° maximum sur tuyauterie horizontale.
- 3** DN700 à DN1200 :
Vanne verticale exclusivement.

RECOMMENDED MOUNTING POSITIONS

- 1** DN40 to DN300 :
Valve vertical, on horizontal pipe
Valve horizontal, on horizontal pipe
Valve horizontal, on vertical pipe
- 2** DN350 to DN600 :
Valve vertical, on horizontal pipe
Valve angled up to 30° maximum from the vertical, on horizontal pipe.
- 3** DN700 to DN1200 :
Valve vertical only.

DN40 → DN300

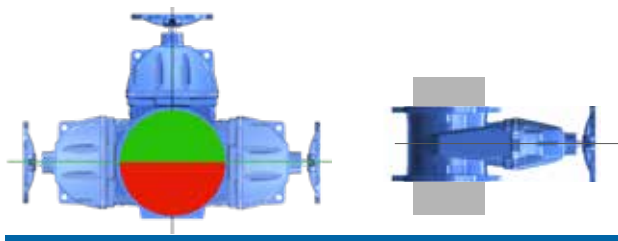

1

DN350 → DN600

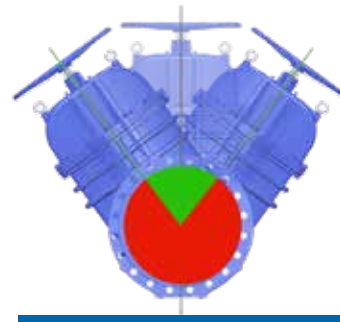

2

DN700 → DN1200



3

VANNES À PASSAGE DIRECT

GATE VALVES

V1142A

Laiton PN16 | Brass PN16

Vanne à passage direct femelle BSP laiton PN16
Female BSP brass gate valve PN16



ACS



Corps : Laiton
Volant : Fonte
Chapeau : Laiton
Opércule : Laiton
Joint de tige : PTFE
Joint de chapeau : PTFE
Raccordement : Femelle BSP
Pression de service : 16 bar
Température de service : -10°C/+80°C

Body: Brass
Handwheel: Cast Iron
Bonnet: Brass
Wedge: Brass
Stem packing: PTFE
Bonnet gasket: PTFE
Connection: Female BSP
Working pressure: 16 bar
Working temperature: -10°C/+80°C

DN		L (mm)	Kg	Ref.
mm	inch			
10	3/8"	41	0,18	V1142A-0010
15	1/2"	43	0,22	V1142A-0015
20	3/4"	44	0,29	V1142A-0020
25	1"	48	0,36	V1142A-0025
32	1 1/4"	50	0,61	V1142A-0032
40	1 1/2"	54,5	0,73	V1142A-0040
50	2"	61	1,10	V1142A-0050
65	2 1/2"	62,5	1,95	V1142A-0065
80	3"	73	2,60	V1142A-0080
100	4"	78	4,60	V1142A-0100

V2143W

Bronze PN20 | Bronze PN20

Vanne à passage direct femelle BSP bronze PN20
Female BSP bronze gate valve PN20



DN15 50 :



Corps : Bronze
Volant :
1/2" - 2" : Aluminium
2 1/2" - 4" : Fonte
Chapeau : Bronze
Opércule : Bronze
Joint de tige : Laiton
Joint : PTFE
Raccordement : Femelle BSP
Pression de service : 20 bar
Température de service : -10°C/+170°C

Body: Bronze
Handwheel:
1/2" - 2" : Aluminium
2 1/2" - 4" : Cast Iron
Bonnet: Bronze
Wedge: Bronze
Stem packing: Brass
Gasket: PTFE
Connection: Female BSP
Working pressure: 20 bar
Working temperature: -10°C/+170°C

DN		L (mm)	Kg	Ref.
mm	inch			
15	1/2"	43	0,25	V2143W-0015
20	3/4"	49	0,35	V2143W-0020
25	1"	54	0,52	V2143W-0025
32	1 1/4"	62	0,77	V2143W-0032
40	1 1/2"	65	1,06	V2143W-0040
50	2"	75	1,61	V2143W-0050
65	2 1/2"	87	2,97	V2143W-0065
80	3"	105	4,78	V2143W-0080
100	4"	124	8,61	V2143W-0100

V6140

Inox PN16 | Stainless Steel

Vanne à opércule femelle BSP inox PN16
Female BSP Stainless steel gate valve PN16



Corps : ASTM A351 CF8M
Volant : Zamak
Opércule : ASTM A351 CF8M
Joints de corps et de presse étoupe : PTFE
Raccordement : Femelle BSP
Pression de service : 16 bar
Température de service : -20°C/+180°C

Body: ASTM A351 CF8M
Handwheel: Zamak
Gate: ASTM A351 CF8M
Packing & gasket: PTFE
Connection: Female BSP
Working pressure: 16 bar
Working temperature: -20°C/+180°C

DN		L (mm)	Kg	Ref.
mm	inch			
15	1/2"	55	0,44	V6140-0015
20	3/4"	60,5	0,57	V6140-0020
25	1"	65,5	0,74	V6140-0025
32	1 1/4"	76,5	1,12	V6140-0032
40	1 1/2"	85,5	1,55	V6140-0040
50	2"	95,5	2,25	V6140-0050



V3200

F4 PN10 (EN558-1 Serie 14) / DIN 3202 F4

Vanne à passage direct F4 tige non montante PN10

F4 Non-rising stem gate valve PN10



Corps : Fonte GG25
 Obturateur : Fonte ductile GGG40
 Raccordement : A brides PN10
 Etanchéité : Alliage cuivreux
 Pression de service max :
 DN 40 - 300 : 10 bar
 DN 350 - 400 : 4 bar
 Température de service max : +120°C

Body: Cast Iron GG25
 Wedge: Ductile iron GGG40
 Connection: Flanged PN10
 Seal: Copper alloy
 Maximum working pressure:
 DN 40 - 300 : 10 bar
 DN 350 - 400 : 4 bar
 Maximum Working temperature: +120°C

DN		L (mm)	Kg	Ref.
mm	inch			
40	1"1/2	140	8,7	V3200-0040
50	2"	150	10,8	V3200-0050
65	2"1/2	170	12,8	V3200-0065
80	3"	180	16,6	V3200-0080
100	4"	190	22,8	V3200-0100
125	5"	200	32,1	V3200-0125
150	6"	210	42,9	V3200-0150
200	8"	230	71,3	V3200-0200
250	10"	250	98	V3200-0250
300	12"	270	145,2	V3200-0300
350	14"	290	211	V3200-0350
400	16"	310	275	V3200-0400

V4246

F4 PN16 (EN558-1 Serie 14) / DIN 3202 F4

Vanne à passage direct F4 tige non montante PN16

Non-rising stem gate valve F4 PN16



Corps : Fonte Ductile GGG50
 Obturateur : Fonte Ductile GGG50
 Raccordement : A brides PN16
 Etanchéité : Alliage cuivreux
 Pression de service max : 16 bar
 Température de service max : +120°C

Body: Ductile iron GGG50
 Wedge: Ductile iron GGG50
 Connection: Flanged PN16
 Seal: Copper alloy
 Maximum Working pressure: 16 bar
 Maximum working temperature: +120°C

DN		L (mm)	Kg	Ref.
mm	inch			
40	1"1/2	140	8,7	V4246-0040
50	2"	150	10,8	V4246-0050
65	2"1/2	170	12,8	V4246-0065
80	3"	180	16,6	V4246-0080
100	4"	190	22,8	V4246-0100
125	5"	200	32,1	V4246-0125
150	6"	210	42,9	V4246-0150
200	8"	230	71,3	V4246-0200
250	10"	250	98	V4246-0250
300	12"	270	145,2	V4246-0300

V4242

F4 Tige montante PN16 | Rising stem PN16 (EN558-1 Serie 14) / DIN 3202 F4

Vanne à passage direct tige montante PN16

Rising stem gate valve PN16



Corps : Fonte Ductile EN-GJS-500-7
 Opercule : Fonte Ductile EN-GJS-500-7
 Raccordement : A brides PN16
 Presse étoupe : Graphite
 Siège : Alliage cuivreux
 Pression de service : 16 bar
 Température de service max : +180°C

Body: Ductile iron EN-GJS-500-7
 Gate: Ductile iron EN-GJS-500-7
 Connection: Flanged PN16
 Packing: Graphite
 Seat: Cast brass
 Working pressure: 16 bar
 Max. Working temperature: +180°C

DN		L (mm)	Kg	Ref.
mm	inch			
40	1"1/2	140	9,8	V4242-0040
50	2"	150	11,9	V4242-0050
65	2"1/2	170	13,3	V4242-0065
80	3"	180	17,2	V4242-0080
100	4"	190	23,2	V4242-0100
125	5"	200	34,2	V4242-0125
150	6"	210	44,4	V4242-0150
200	8"	230	67,5	V4242-0200
250	10"	250	110	V4242-0250
300	12"	270	155	V4242-0300

V4250 | V4260

F5 PN25 / PN40 (EN558-1 Serie 15) / DIN 3202 F5

Vanne à passage direct F5 tige non montante

F5 Non-rising stem gate valve



Corps : Fonte GGG40
 Volant : Fonte
 Obturateur : Fonte GGG40
 Tige : Inox 420
 Etanchéité : Bronze
 Raccordement : A brides
 Température de service max : -10°C/+80°C

Body: Ductile iron GGG40
 Handwheel: Cast Iron
 Wedge: Ductile iron GGG40
 Stem: Stainless steel 420
 Tightness: Bronze
 Connection: Flanged
 Working temperature: -10°C/+80°C

DN			PN25		PN40	
mm	inch	L (mm)	Kg	Ref.	Kg	Ref.
40	1"1/2	240	15	V4250-0040	15	V4260-0040
50	2"	250	15	V4250-0050	15	V4260-0050
65	2"1/2	270	21	V4250-0065	21	V4260-0065
80	3"	280	21	V4250-0080	21	V4260-0080
100	4"	300	31	V4250-0100	32	V4260-0100
125	5"	325	51	V4250-0125	51	V4260-0125
150	6"	350	62	V4250-0150	65	V4260-0150
200	8"	400	100	V4250-0200	116	V4260-0200
250	10"	450	155	V4250-0250	192	V4260-0250
300	12"	500	221	V4250-0300	280	V4260-0300
350	14"	550	324	V4250-0350	324	V4260-0350
400	16"	600	440	V4250-0400	480	V4260-0400
450	18"	650	575	V4250-0450	575	V4260-0450
500	20"	700	760	V4250-0500	760	V4260-0500
600	24"	800	1180	V4250-0600	1180	V4260-0600
700	28"	900	1600	V4250-0700	1600	V4260-0700
800	32"	1000	2337	V4250-0800	2337	V4260-0800

VANNES À MANCHON
PINCH VALVES

VM3200

Vanne à manchon à brides à volant PN10

Flanged pinch valve with handwheel PN10



Corps : Fonte d'aluminium
 Manchon : Gomme naturelle anti-abrasion, autres sur demande
 Raccordement : A brides PN10
 Pression de service : 3 à 4 bar
 Température de service max : +80°C

Body: Cast aluminium
 Sleeve: Natural rubber, other material on request
 Connection: Flanged PN10
 Working pressure: 3 to 4 bar
 Max Working temperature: +80°C

DN		L (mm)	Kg	Ref.
mm	inch			
15	1/2"	80	1,5	VM3200-00CN0015
20	3/4"	95	3	VM3200-00CN0020
25	1"	106	3,6	VM3200-00CN0025
32	1"	115	5,6	VM3200-00CN0032
40	1"1/2	140	8	VM3200-00CN0040
50	2"	160	10,3	VM3200-00CN0050
65	2"1/2	190	15	VM3200-00CN0065
80	3"	196	18	VM3200-00CN0080
100	4"	260	28	VM3200-00CN0100
125	5"	280	40	VM3200-00CN0125
150	6"	300	51	VM3200-00CN0150
200	8"	350	72	VM3200-00CN0200



Commande pneumatique double ou simple effet en option.
 Single or double-acting pneumatic actuator optional.



Idéal pour boues, matériaux granulaires, poudres, pâtes.
Manchon interchangeable sans outil spécifique. Faibles pertes de charge.
 Used for slurries, granular materials, powders, pastes.
 Replaceable sleeve without any special tools. Low head losses.



VM8201-07

Vanne à manchon à brides à vérin pneumatique simple effet PN10

Flanged pinch valve with single acting pneumatic actuator PN10



Corps : Fonte d'aluminium
Manchon : Gomme naturelle anti-abrasion, autres sur demande
Raccordement : A brides PN10
Commande par vérin pneumatique simple effet avec commande manuelle de secours
Pression de service : 4 bar
Pression d'alimentation air : 4 à 6 bar
Température de service max : +80°C

Body : Cast aluminium
Sleeve : Natural rubber, other material on request
Connection : Flanged PN10
Single-acting pneumatic actuator with emergency handwheel
Working pressure : 4 bar
Air pressure supply : 4 up to 6 bar
Max working temperature : +80°C

DN		L (mm)	Kg	Normalement Ouvert	Normalement Fermé
mm	inch			Normally Open	Normally Closed
				Ref.	Ref.
20	3/4"	95	3	VM8201-07NO-CN0020	VM8201-07NF-CN0020
25	1"	106	4,5	VM8201-07NO-CN0025	VM8201-07NF-CN0025
32	1"	115	5,2	VM8201-07NO-CN0032	VM8201-07NF-CN0032
40	1 1/2"	140	7,7	VM8201-07NO-CN0040	VM8201-07NF-CN0040
50	2"	160	9	VM8201-07NO-CN0050	VM8201-07NF-CN0050
65	2 1/2"	190	13,5	VM8201-07NO-CN0065	VM8201-07NF-CN0065
80	3"	196	15	VM8201-07NO-CN0080	VM8201-07NF-CN0080
100	4"	260	23	VM8201-07NO-CN0100	VM8201-07NF-CN0100
125	5"	280	33	VM8201-07NO-CN0125	VM8201-07NF-CN0125
150	6"	300	43,5	VM8201-07NO-CN0150	VM8201-07NF-CN0150
200	8"	-	-	VM8201-07NO-CN0200	VM8201-07NF-CN0200

VM9101

Vanne à manchon pneumatique taraudée PN10

Female BSP pneumatic pinch valve



Corps : POM
Manchon : Gomme naturelle anti-abrasion
Raccordement : Femelle BSP
Pression de service : 6 bar
Température de service max : +80°C

Body : POM
Sleeve : Natural rubber
Connection : Female BSP
Working pressure : 6 bar
Max working temperature : +80°C

DN		L (mm)	Kg	Ref.
mm	inch			
10	3/8"	80	0,12	VM9101-0010
15	1/2"	95	0,31	VM9101-0015
20	3/4"	103	0,31	VM9101-0020
25	1"	120	0,50	VM9101-0025
32	1 1/4"	135	0,66	VM9101-0032
40	1 1/2"	160	0,97	VM9101-0040
50	2"	170	1,50	VM9101-0050

VM8200

Vanne à manchon pneumatique à brides PN10

Flanged pneumatic pinch valve PN10



Corps : Fonte d'aluminium
Manchon : Gomme naturelle anti-abrasion
Brides : Fonte d'aluminium
Raccordement : A brides PN 10
Pression de service :
 DN40-150 : 6 bar
 DN200 : 4 bar
Température de service max :
 -40°C/+80°C

Body : Cast aluminium
Sleeve : Natural rubber
Flanges : Cast aluminium
Connection : Flanged PN10
Working pressure :
 DN40-150: 6 bar
 DN200: 4 bar
Max working temperature :
 -40°C/+80°C

DN	L	Kg	Ref.
40	155	3,2	VM8200-00CN0040
50	183	3,5	VM8200-00CN0050
65	183	5	VM8200-00CN0065
80	228	6	VM8200-00CN0080
100	281	8	VM8200-00CN0100
125	350	12	VM8200-00CN0125
150	420	17	VM8200-00CN0150
200	560	35	VM8200-00CN0200

SUR DEMANDE | ON REQUEST

Autres manchons (EPDM, FPM, Silicone, NBR, CSM, IIR)
 Other sleeves (EPDM, FPM, Silicone, NBR, CSM, IIR)



Electrovanne (voir page 304)
Solenoid valve (voir page 304)